

Pfaff 1493 E1
Subclass

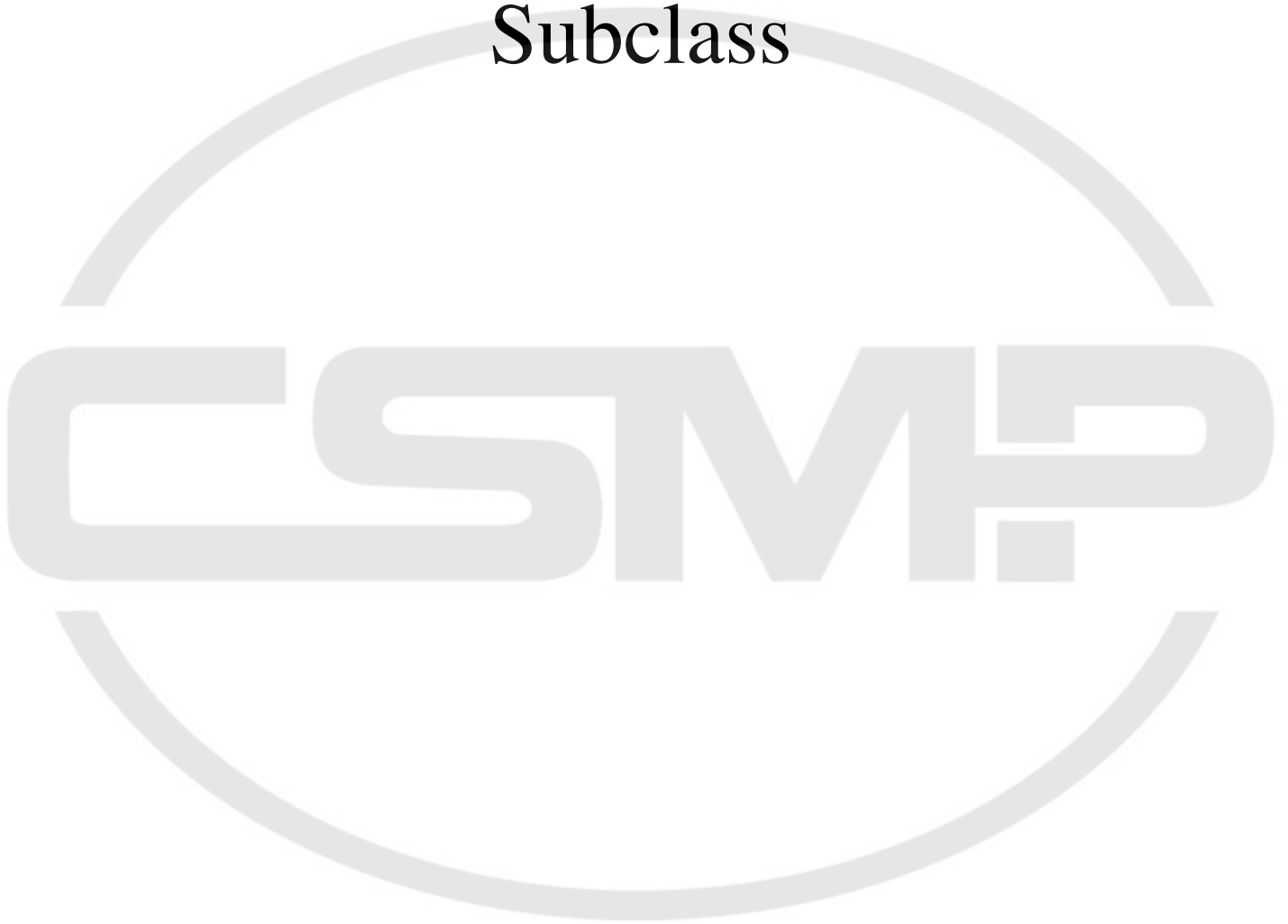

PFAFF

1493 E1

Unterklassen-Ausstattung

Subclass parts

Composition des sous-classes

Composición de las subclases





CSMP

Unterklassen-Übersicht
Table of subclasses
Table des sous-classes
Tabla de subclases **PFAFF 1493 E1**

Unterklasse Subclass Sous-classe Subclase	-755/13-59/01-900/53	-755/13-59/01-900/53	-755/13-725/04-900/53	-755/13-725/04-900/53
Arbeitsgang Operation Opération Operación				
Ausführung Model Version Tipo de máquina	AN5	BN5	AN5	BN5
Schneidabstand in mm Trimming margin in mm Distance de coupe en mm Margen de corte en mm			0,8 - 2,5	1,2 - 2,5
Nadelstange Needle bar Barre à aiguille Barra de aguja	91-119 440-91	91-119 440-91	91-175 110-91	91-175 110-91
Rollfuß ⁴ Roller presser Pied à roulette Pie rodante	91-164 907-91 ^{70/10} ^{90/71}	91-164 907-91 ^{70/10} ^{90/71}	91-164 303-93 ^{70/11} ^{90/70}	91-164 303-93 ^{70/11} ^{90/70}
Stichplatte ⁴ Needle plate Plaque à aiguille Placa de aguja	91-150 651-03	91-150 651-03	91-158 261-93 ^{9/2}	91-158 261-93 ^{9/2}
Schiebrad ⁴ Feed wheel Roue d'entraînement Rueda transportadora	91-119 544-05	91-119 546-05	91-119 544-05	91-119 546-05
Lineal Edge guide Guide-droit Guía recta	91-164 142-91 91-156 114-05	91-164 142-91 91-156 114-05	91-164 142-15 91-156 114-05	91-164 142-15 91-156 114-05
Bandvorführung Tape guide Guide-ruban Guía para cinta	91-164 765-91 91-164 761-71/895	91-164 765-91 91-164 761-71/895		
Bandrollenträger Tape reel bracket Plateau dérouleur Portarollos	91-026 558-70/895	91-026 558-70/895		
Bandtrommel Tape reel Tambour-dérouleur Tambor portacintas	91-056 758-70/895	91-056 758-70/895		
Träger Bracket Support Soporte	91-170 458-72/895	91-170 458-72/895		
Messer ^{18/2} Knife Couteau Cuchilla			91-011 165-04 ¹⁸ = 2,7; 3,0; 3,5 mm	91-011 165-04 ¹⁸ = 2,7; 3,0; 3,5 mm

Unterklassen-Übersicht
Table of subclasses
Table des sous-classes
Tabla de subclases

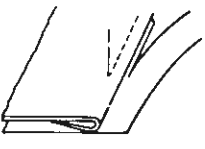
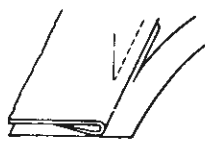
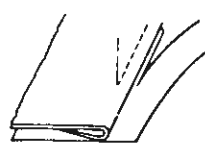
PFAFF 1493 E1







Unterklasse Subclass Sous-classe Subclase	-755/13-725/04-900/53	-755/13-726/05-900/53	-755/13-726/05-900/53	-755/13-726/05-900/53
Arbeitsgang Operation Opération Opéracion				
Ausführung Model Version Tipo de máquina	B/CN5	AN5	BN5	B/CN5
Schneidabstand in mm Trimming margin in mm Distance de coupe en mm Margen de corte en mm	1,5 - 2,5	0,8 - 2,5	1,2 - 2,5	1,5 - 2,5
Nadeistange Needle bar Barre à aiguille Barra de aguja	91-175 110-91	91-175 110-91	91-175 110-91	91-175 110-91
Rollfuß ^[4] Roller presser Pied à roulette Pie rodante	91-164 303-93 ^[70/1] ^[90/70]	91-164 303-93 ^[70/1] ^[90/70]	91-164 303-93 ^[70/1] ^[90/70]	91-164 303-93 ^[70/1] ^[90/70]
Stichplatte ^[4] Needle plate Plaque à aiguille Placa de aguja	91-158 263-93 ^[9/2]	91-158 261-93 ^[9/2]	91-158 261-93 ^[9/2]	91-158 263-93 ^[9/2]
Schneibrad ^[4] Feed wheel Roue d'entraînement Rueda transportadora	91-119 546-05	91-119 544-05	91-119 546-05	91-119 546-05
Lineal Edge guide Guide-droit Guía recta	91-164 142-91 91-156 114-05	91-164 100-91	91-164 100-91	91-164 100-91
Bandvorführung Tape guide Guide-ruban Guía para cinta				
Bandrollenträger Tape reel bracket Plateau dérouleur Portarollos				
Bandtrommel Tape reel Tambour-dérouleur Tambor portacintas				
Träger Bracket Support Soporte				
Messer ^[18/2] Knife Couteau Cuchilla	91-011 165-04 ^[18] = 2,7; 3,0; 3,5 mm	91-011 324-04 ^[18] = 2,7; 3,0; 3,5 mm	91-011 324-04 ^[18] = 2,7; 3,0; 3,5 mm	91-011 324-04 ^[18] = 2,7; 3,0; 3,5 mm

siehe Erläuterungen Register 0
see explanations in section 0
voir légende registre 0
ver explicaciones del registro 0

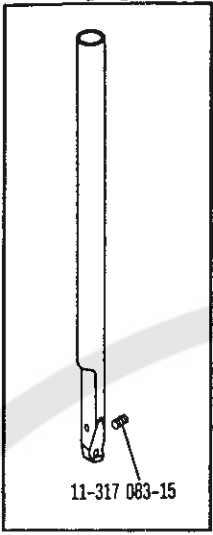
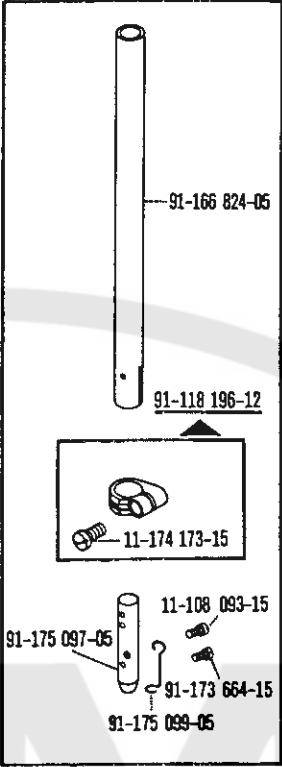
Unterklassen-Übersicht
Table of subclasses
Table des sous-classes
Tabla de subclases

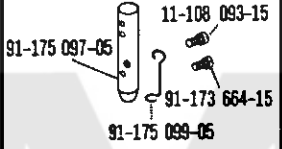
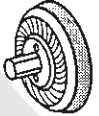
PFAFF 1493 E1

Unterklasse Subclass Sous-classe Subclase	-755/13-900/53	-755/13-900/53	-755/13-900/53
Arbeitsgang Operation Opération Operación	Zum Herstellen von Zier- und Befestigungsnähten. Schiebradtransport und angetriebener Rollfuß. For sewing fancy seams and assembly seams. Wheel feed and driven roller presser. Pour exécuter les coutures d'ornementation et de fixation. Avec entraînement par rove et pied à roulette entraînée. Para ejecutar costuras de adorno y fijación. Transportador inferior de rueda y pie rodante accionado.	Zum Herstellen von Zier- und Befestigungsnähten. Schiebradtransport und angetriebener Rollfuß. For sewing fancy seams and assembly seams. Wheel feed and driven roller presser. Pour exécuter les coutures d'ornementation et de fixation. Avec entraînement par rove et pied à roulette entraînée. Para ejecutar costuras de adorno y fijación. Transportador inferior de rueda y pie rodante accionado.	Zum Herstellen von Zier- und Befestigungsnähten. Schiebradtransport und angetriebener Rollfuß. For sewing fancy seams and assembly seams. Wheel feed and driven roller presser. Pour exécuter les coutures d'ornementation et de fixation. Avec entraînement par rove et pied à roulette entraînée. Para ejecutar costuras de adorno y fijación. Transportador inferior de rueda y pie rodante accionado.
Ausführung Model Version Tipo de máquina	AN5	BN5	B/CN5
Schneidabstand in mm Trimming margin in mm Distance de coupe en mm Margen de corte en mm			
Nadelstange Needle bar Barre à aiguille Barra de aguja	91-175 110-91	91-175 110-91	91-175 110-91
Rollfuß ⁴ Roller presser Pied à roulette Pie rodante	91-164 303-93 ^{70/1} ^{90/70}	91-164 303-93 ^{70/1} ^{90/70}	91-164 303-93 ^{70/1} ^{90/70}
Stichplatte ⁴ Needle plate Plaque à aiguille Placa de aguja	91-150 544-93	91-150 544-93	91-150 546-93
Schiebrad ⁴ Feed wheel Roue d'entraînement Rueda transportadora	91-119 544-05	91-119 546-05	91-119 546-05
Lineal Edge guide Guide-droit Guía recta			
Bandvorführung Tape guide Guide-ruban Guía para cinta			
Bandrollenträger Tape reel bracket Plateau dérouleur Portarollos			
Bandtrommel Tape reel Tambour-dérouleur Tambor portacintas			
Träger Bracket Support Soporte			
Messer ^{1B/2} Knife Couteau Cuchilla			

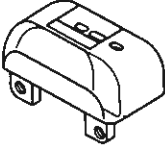
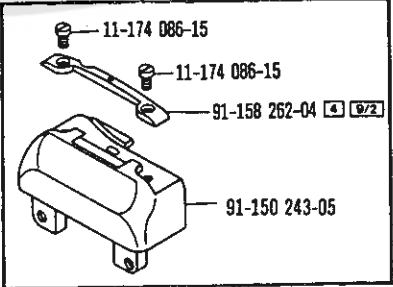
<p style="text-align: center;">91-119 440-91</p>  <p style="text-align: center;">11-317 083-15</p> <p style="text-align: right;">-755/13-59/01-900/53</p>	<p style="text-align: center;">91-175 110-91</p>  <p style="text-align: center;">91-166 824-05</p> <p style="text-align: center;">91-118 196-12</p>  <p style="text-align: center;">11-174 173-15</p>  <p style="text-align: center;">11-108 093-15</p> <p style="text-align: center;">91-175 097-05</p> <p style="text-align: center;">91-173 664-15</p> <p style="text-align: center;">91-175 099-05</p> <p style="text-align: right;">-755/13-725/04-900/53 -755/13-726/05-900/53 -755/13-900/53</p>		
<p style="text-align: center;">91-164 303-93 A 70/13 9070</p>  <p style="text-align: right;">-755/13-725/04-900/53 -755/13-726/05-900/53 -755/13-900/53</p>	<p style="text-align: center;">91-164 907-91 A 70/13 9071</p>  <p style="text-align: right;">-755/13-59/01-900/53</p>	<p style="text-align: center;">91-164 939-91 A 28 70/13 9071</p>  <p style="text-align: right;">-755/13-725/04-900/53 -755/13-726/05-900/53 -755/13-900/53</p>	<p style="text-align: center;">91-164 941-91 A 28 70/13 9070</p>  <p style="text-align: right;">-755/13-725/04-900/53 -755/13-726/05-900/53 -755/13-900/53</p>
<p style="text-align: center;">91-150 651-03 A</p>  <p style="text-align: right;">-755/13-725/04-900/53 -755/13-726/05-900/53</p>	<p style="text-align: center;">91-158 261-93 A B A 9/2</p>  <p style="text-align: center;">11-174 086-15</p> <p style="text-align: center;">11-174 086-15</p> <p style="text-align: center;">91-158 262-04 A 9/2</p> <p style="text-align: center;">91-150 243-05</p> <p style="text-align: right;">-755/13-725/04-900/53 -755/13-726/05-900/53</p>		

siehe Erläuterungen Register 0
 see explanations in section 0
 voir légende registre 0
 ver explicaciones del registro 0

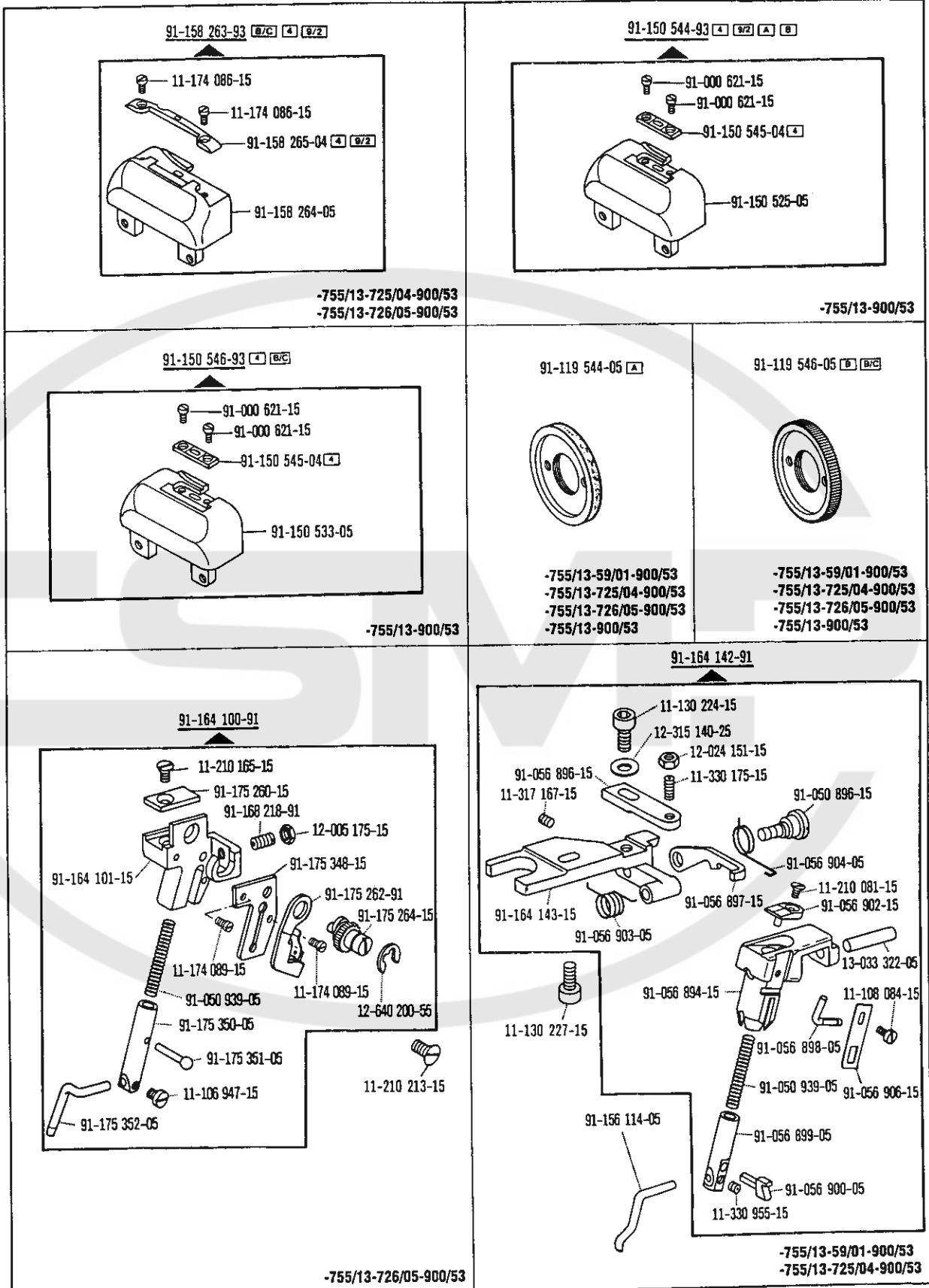

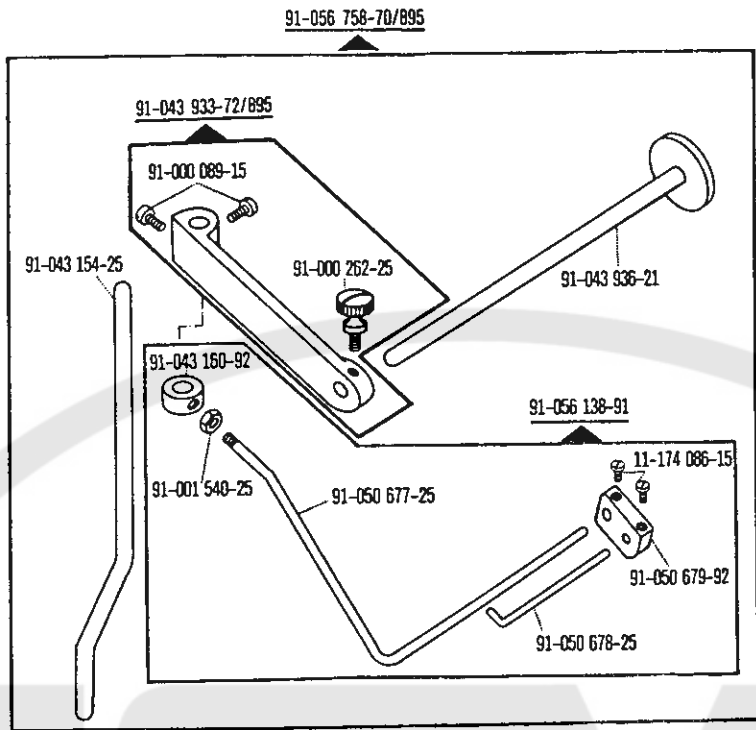

-755/13-59/01-900/53

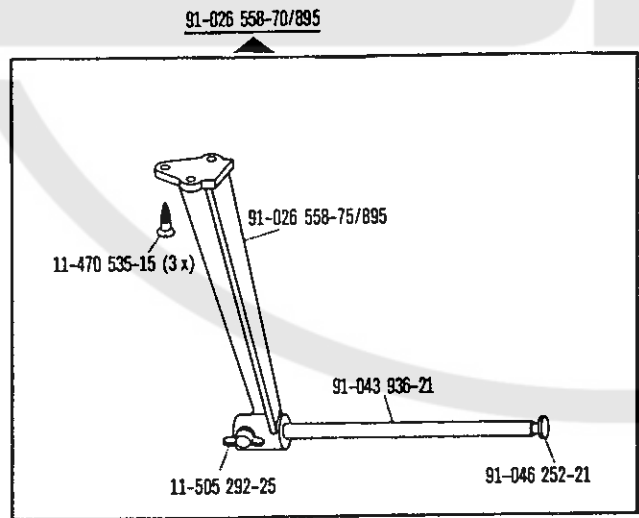

-755/13-59/01-900/53

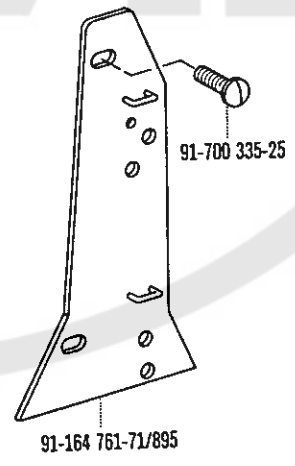

-755/13-59/01-900/53

☐ siehe Erläuterungen Register 0
 see explanations in section 0
 voir légende registre 0
 ver explicaciones del registro 0

